

Specifications: Model VB-303(7) NPT Valve

Vertical - Bottom In Flow

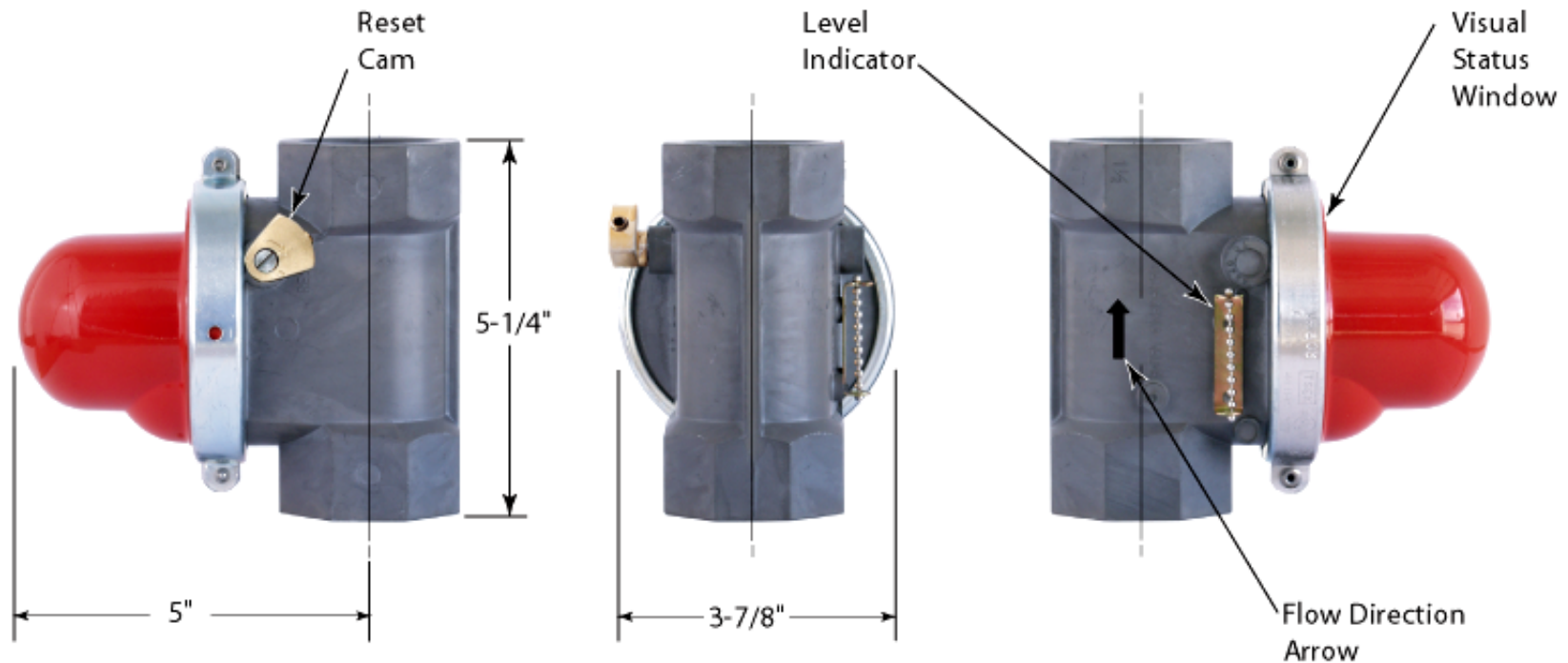

Valve Model#	CA-DSA No.	Length	Height	Width	Nominal Pipe Size	Threads Per Inch	APPLICATION DATA	
							Max. Pressure	Fuel
VB-303(7)	60-01	5"	5-1/4"	3-7/8"	1-1/2"	11-1/2	7.0 psi	Dry Fuel Gas

