

KAL-D06

Miniature, Low Cost, LCD, 8 Digit Electronic Counter

Features

- 8 Digits Standard
- Meets NEMA 4X and IP65 Ratings
- Long Life (10 Year) Lithium Battery
- 10 kHz Count Speed
- Screw Terminal Block
- Slow Speed Input for Contact Closures
- High Speed Input for Sinking Inputs from a Max. of 18VDC Without Module
- Quadrature and High Voltage (10 to 240 V AC; 10 to 110V DC) Inputs Optional
- UL Recognized Component

Description:

The KAL-D06 counters are small, lithium battery powered, totalizing counters that are panel mounted. The counters are designed as replacements for standard electro-mechanical counters. They use the latest custom CMOS technology and incorporate an 8 digit, 0.354" (9mm) high, LCD display.

It operates from a long life lithium battery (life 10 years) and can be operated from contact closure or high speed electronic devices. No separate alkaline batteries are required. The front reset button can be disabled if desired.

Specifications:

Battery: Non-replaceable Lithium battery, expected life of 10 years at 20°C

Display: 8 digit black LCD, Digit size 0.354" (9mm) high, leading zero blanking,

Backlight: backlight requires external 5V supply ($\pm 0.5V$ @ 20mA). 12V, 24V and 30V can be used with the use of an external resistor, see backlight wiring diagram for details and resistor values.

Reset: Panel or remote (can be disabled if desired)

Count Range: 0-99999999, rollover to 0

Temperature Range:

Operating: 14 to 140°F (-10 to 60°C)
Storage: -4 to 140°F (-20 to 60°C)

Battery Life: 10 years at 20°C (calculated)

Relative Humidity: 80% max. up to 31°C, decreasing to 50% max. at 40°C

Connection: Finger-proof screw terminal for wires up to 0.06"² (1.5mm²)

Sealing: NEMA 4X/IP65; **Remove film from self adhesive gasket before use!** Overvoltage Category II, Pollution Fegree 2 (IEC 64)

Certifications: UL Recognized Component



KAL-D06 Wiring:

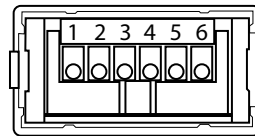

- 1 - High Speed Count Input
- 2 - Low Speed Count Input
- 3 - External Reset Input
- 4 - Direction Input
- 5 - External Power for Backlight
- 6 - 0V, Common

High Speed Count Input:

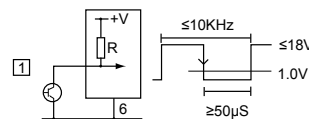

- Sink input NPN
- R = Internal resistor 3.3M Ω
- Max 18V, theshold 1V
- Negative edge trigger
- Max. 10kHz, min. 50 μ S

Low Speed Count Input:

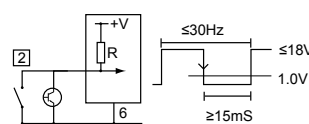

- Sink input NPN or contact closure
- R = Internal resistor 3.3M Ω
- Max 18V, theshold 1V
- Negative edge trigger
- Max. 30Hz, min. 15ms

External Reset Input:

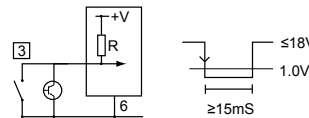

- Sink input NPN or contact closure
- R = Internal resistor 3.3M Ω
- Max 18V, theshold 1V
- Negative edge trigger
- Min. 15ms

Direction Input:

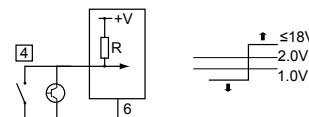

- Sink input NPN or contact closure
- R = Internal resistor 3.3M Ω
- UP: Not connected or >2V (logic 1), max 18V
- DOWN: Connected to common or <1V (logic 0)
- Direction signal must change >5 μ S before Count signal.

KAL-DQUAD06 Wiring

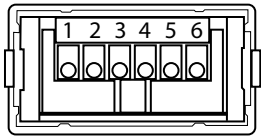

- 1 - Count Input A
- 2 - Count Input B
- 3 - External Reset Input
- 4 - Not used
- 5 - External Power for Backlight and Input Circuit
- 6 - 0V, Common

Quadrature Input:

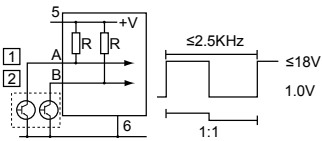

- Count Inputs A & B**
- Sink input NPN or push-pull signals, NOT source only
 - R = Internal resistor 3.3M Ω
 - Max. +V
 - Max. 2.5kHz
 - Mark to space ratio 1:1

KAL-D06AC/DC Wiring

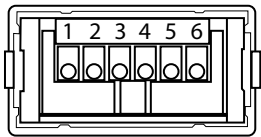

- 1 - High Voltage Count Input
- 2 - High Voltage External Reset Input
- 3 - Common for pins 1 & 2
- 4 - Direction Input
- 5 - External Power for Backlight
- 6 - 0V, Common for pins 4 & 5

High Voltage Input:

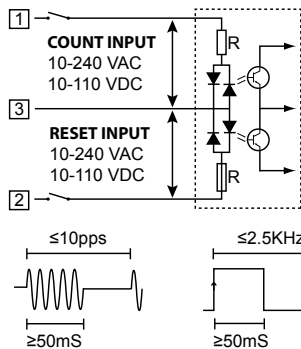

- High Voltage Count Input**
- Opto-isolated
 - R = Internal resistor 50k Ω
 - 10 - 240V AC $\pm 10\%$
 - 10 - 110V DC $\pm 10\%$
 - Max. 10 pulses per second
 - Min 50mS
- High Voltage Reset Input**
- Opto-isolated
 - R = Internal resistor 50k Ω
 - 10 - 240V AC $\pm 10\%$
 - 10 - 110V DC $\pm 10\%$
 - Min 15mS

Backlight Wiring

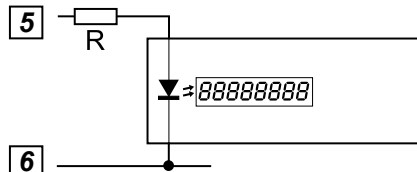

- 5V: R = 0 Ω
- 12V: R = 360 Ω
- 24V: R = 1K Ω
- 30V: R = 1.2K Ω

External supply for backlight is 5 VDC @ 20mA
R = external resistor; see table next to diagram above.

Jumpers

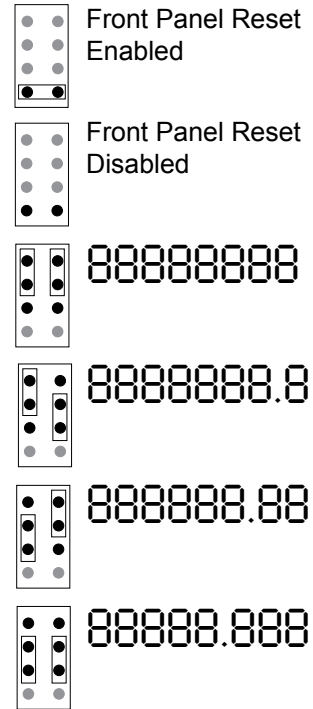
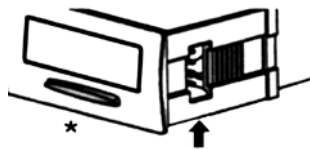

How To Order:

- KAL-D06** 8 digit counter with 10 yr battery
- KAL-DQUAD06** 8 digit counter with 10 yr battery with Quadrature Input
- KAL-D06AC/DC** 8 digit counter with 10 yr battery with High Voltage Input

Accessories

- N7** - Explosion proof housing (see accessories section)
- E200** - Outdoor Enclosure (see accessories section)

Dimensions

