

3" FlowMax®

Flanged CL 150

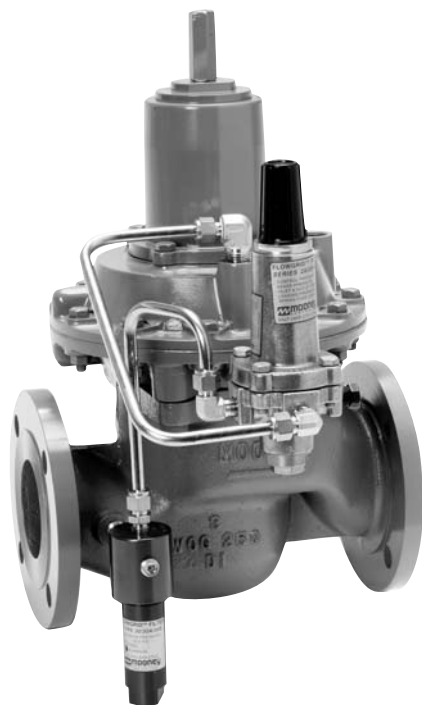

3" FlowMax® Low Differential Regulator with Series 20 Pilot and Type 30 Filter

OVERPRESSURE PROTECTION

The FlowMax® valve has a full ANSI rating of 250 psi on both the inlet and outlet connections as well as the actuator housing assembly. Overpressure protection is required only if the pressure can exceed the flange or body rating.

The pilots, like most regulators, may have an outlet pressure rating lower than the inlet pressure rating. If this is the case, then some external form of overpressure protection must be provided for the pilot.

Anytime the FlowMax® valve or pilot system is exposed to pressures in excess of its rating it should be inspected for damage.

The 3" Single Port FlowMax® regulator is an economical and easy to maintain pilot loading type regulator specifically designed for low differential pressure applications. The valve is designed to be used in conjunction with a self contained pilot control system to provide exceptional pressure control.

SPECIFICATIONS

Size	3"
Body Style	Single Port
End Connections	3" CL 150 Flanged
Temperature	Working -20°F to 150°F Emergency -40°F to 175°F
Max. Operating Differential	250 psi
Max. Casing Pressure	250 psi
Min. Differential	4 psid
Max. Inlet Pressure	250 psig*
Outlet Pressure Range	Series 20L: 5" w.c to 8 psi Series 20: 3 psi to 248 psi
Pilot Supply Body Tap	One 1/4"-18 NPT
Sense Line Tap	One 1/2"-14 NPT

*Limited by pilot or flange rating

MATERIALS OF CONSTRUCTION

Body	ASTM A 395 Ductile Iron
Actuator Housing	A 356-T6 Cast Aluminum
Spring Case	A 356-T6 Cast Aluminum
Plug/Seat	Nitrile/18-8 SST
Diaphragms	Nitrile/Nylon
O-Ring & Seals	Nitrile
Bolting	ASTM B8 or Equal
Spring	Music Wire

STOCK NUMBERS

3" FlowMax® Valve	Stock Number	Stock Number w/Indicator	Weight
150 CL RF Flanged	FM-4	FM-4T	59 lbs.
150 CL FF Flanged	FM-5	FM-5T	59 lbs.

DIMENSIONS

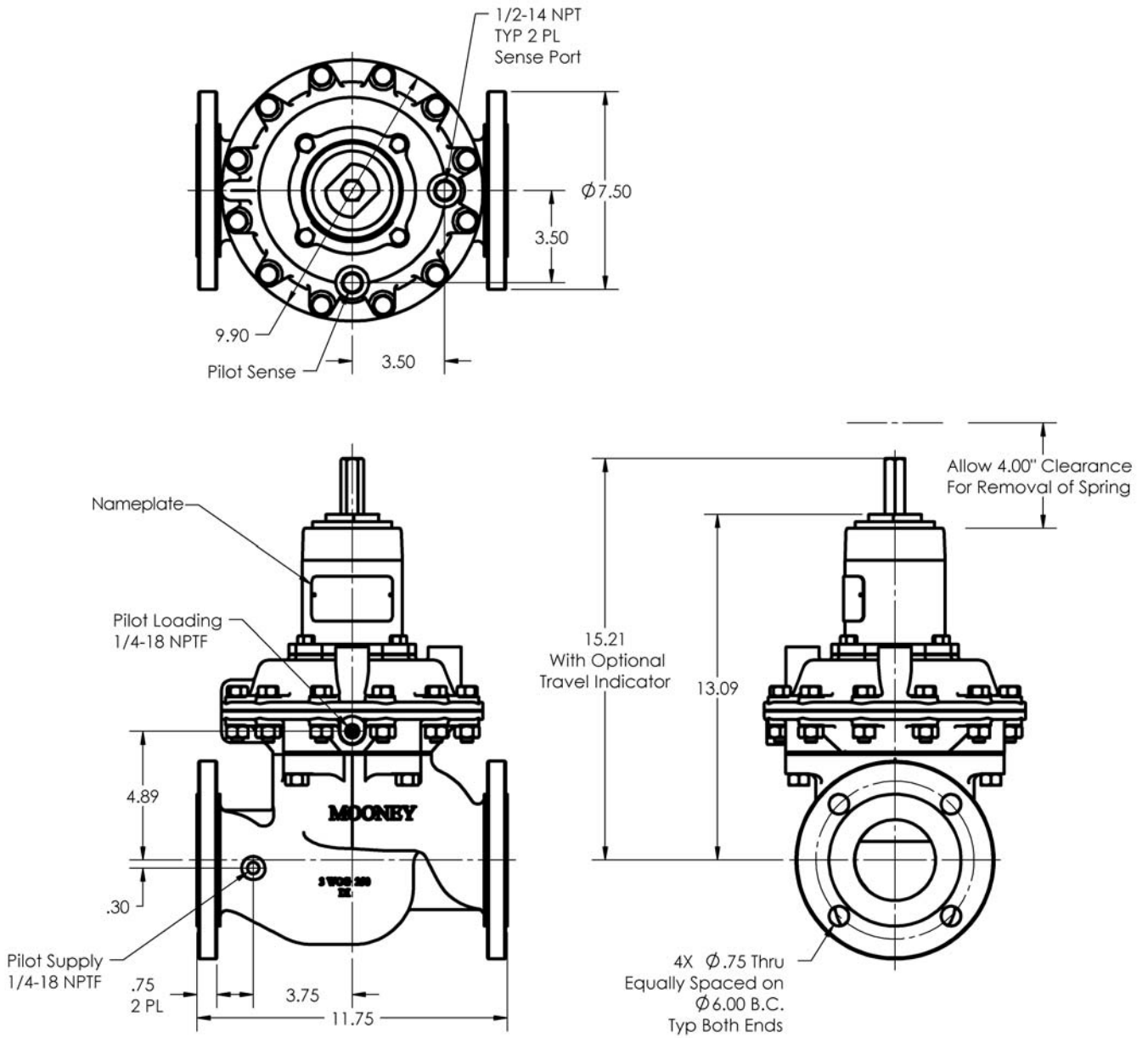

FLOW COEFFICIENTS AND CONSTANTS

3" FlowMax® Single Port Valve			
Percent Capacity	Cv	C1	Cg
100%	114	37	4200
50%	66	32	2100

**Mooney
Dresser, Inc.**
2822 S. 1030 W.
Salt Lake City, Utah 84119
Phone: 801.487.2225 Fax: 801.487.2587
www.mooneycontrols.com



www.dresser.com